

Blind Prediction on the Seismic Response of a 5 Storey Steel Frame Building on Triple Friction Pendulum Isolators



**Q.T. Ma, J. Watkins, M.R. Cutfield, J.T. O'Hagan,
D. Volynkin & L.M. Wotherspoon**
The University of Auckland, Auckland, New Zealand

SUMMARY:

This paper details an entry into the 2011 Blind Analysis Contest hosted by the Center for Urban Earthquake Engineering (CUEE), Japan. The contest was a part of the larger collaborative NEES TIPS project and the E-Defense Seismic Isolation Test Program. The testing program subjected a full-scale five storey steel frame building to a series of past earthquake motion using the shake table in Miki City, Japan. The first shake table test was conducted with the building situated over triple friction pendulums (TFP). Later, the test was repeated without the base isolation devices. Contest participants were challenged to estimate key building response parameters during these two rounds of shaking with only as-designed information, specifically, without any knowledge on the as-built performance to simulate the experience of an authentic design project. The University of Auckland entry was developed using SAP2000. The notable features of the finite element model included; i) the use of membrane elements connected at frame centrelines to simulate a flexible diaphragm, ii) the simulation of composite floor action through an tuned effective width, iii) the use of SAP2000 fibre hinges as a lumped plasticity approach to model the nonlinear composite action, and iv) the inception of a simplified nonlinear spring arrangement to model the response of the TFPs. A comparison of the blind predictions and the actual experimental results is presented. The results showed that the blind prediction matched two of the three key response parameters very well but not so well in storey drift angles. Good time histories comparison suggests that errors were made in the post analysis calculation or a erroneous definition of drift angle.

Keywords: Triple Friction Pendulum, Blind analysis contest, Fibre model, Seismic response

1. INTRODUCTION

A full-scale five storey steel moment frame building was subjected to a series of tri-axial earthquake motion in August 2011 using the E-Defense shake table facility in Miki City, Japan. These full scale tests were conducted within the U.S. Network for Earthquake Engineering Simulation: Tools for Isolation and Protective System (NEES TIPS) project. NEES TIPS was a collaborative effort between the U.S. NEES and the National Research Institute for Earth Science and Disaster Prevention (NIED) in Japan. The project aimed to address the knowledge gaps that have slowed the uptake of seismic isolation technologies particularly in the U.S. It should be noted that barriers to seismic isolation implementation span across the social, economical and engineering spectrums (Mayes et al. 1990). The NEES TIPS project is only one part of many complementary ongoing efforts.

The NEES TIPS project focused on the technical engineering needs and Ryan et al (2008) summarised these as the needs for,

- Better knowledge in understanding the response and performance of different isolation strategies;
- Techniques for reducing cost associated with design and construction of isolated buildings;
- Tools to design isolated buildings, and
- Education for the broad engineering community and raising awareness of the recent developments and the availability of resource for engineers.

Stemming from these objectives, a series of shake table tests and hybrid tests were commissioned at laboratories in Japan and U.S. The highlight of these tests was the full scale shake table validation tests of a prototype building with and without seismic isolation in Japan. The tests of interest used the Triple Friction Pendulum (TFP) isolators produced by Earthquake Protection System Inc. The performance and the theoretical response of this type of device were described previously by research at the University of California, Berkeley (Fenz and Constantinou 2008; Morgan 2007; Morgan and Mahin 2010).

These shake table tests formed the basis of a Blind Analysis Contest which challenged participants to predict the response of the building given only the construction drawings and manufacturers' specifications, emulating an authentic design and construction project. The contest aimed to stimulate development of efficient modelling techniques incorporating TFPs. Contestants were required to submit four analysis predictions; two pre-test analyses on the isolated and non-isolated building based on the anticipated shake table accelerations, and two post-test analyses based on the actual shake table accelerations. A condition of the contest was that the model and analysis procedures for the pre-test and post-test analyses must be identical.

The contest entries were judged on their predictions on a number of response quantities. The entry with the smallest sum of the square of the differences between predicted and experimental values was considered the winning entry.

1.1 The Prototype Building

The bare prototype building used for the shake table tests and contest was essentially the same as the building first used in 2009 E-Defense Blind Analysis Contest (Motoyui et al. 2009). The building was a steel moment frame with five floors above ground level. The lower two storeys of the building was externally clad with pre-cast autoclaved lightweight concrete (ALC) panels and a glass curtain wall, whilst the higher storeys were exposed. Steel weights were secured to each of the floors to simulate the live load in service. For the isolated tests, the prototype building rested on nine TFP isolators, each situated under one of the columns of the building. Figure 1 below shows the overall dimensions of the building, a photograph of it situated on the shake table and the dimensions of the typical TFP isolator.

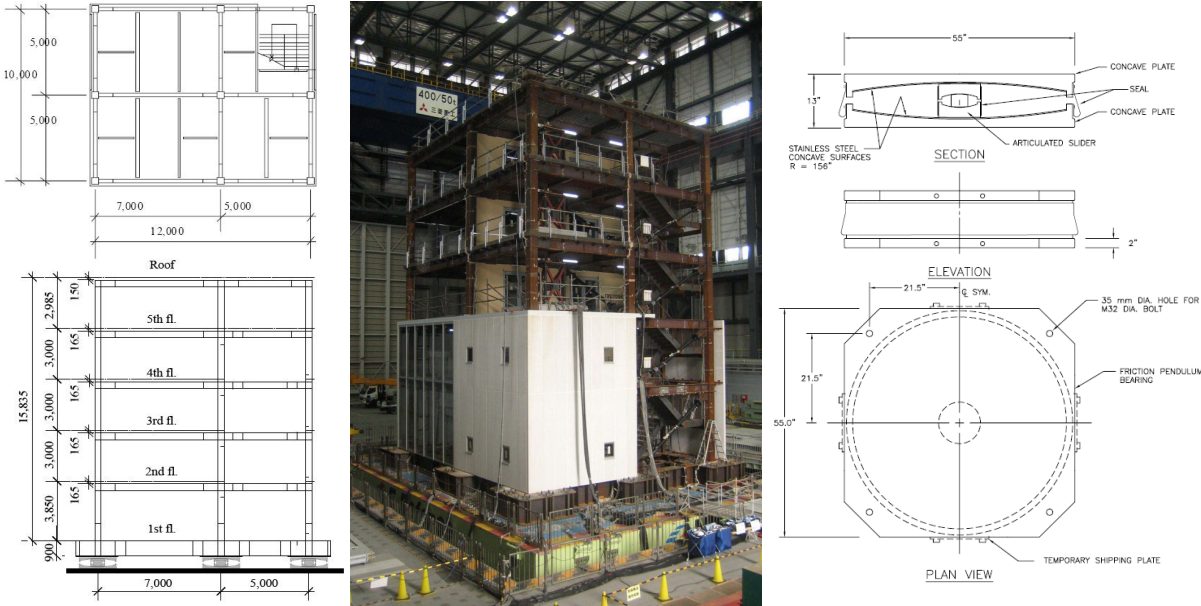

Figure 1. Plan and elevation schematic of the prototype building, a photograph of the building on the E-Defense shake table, and dimensions of the TFP isolators (Source: Center for Urban Earthquake Engineering 2011)

1.2 Test Earthquake Motion

The contest organisers initially chose the 1994 Northridge Earthquake record at Sylmar station as the ground motion for the shake table tests. However due to unexpected damage to non-structural components from the vertical excitation in the preliminary stages of testing, the ground motion was changed to the 2011 Tohoku Earthquake record at Iwanuma Station. Furthermore, to prevent premature damage in the testing, the input amplitudes of these records were set at 100% for the TFP system and 70% of full scale for the fixed-base system.

Figure 2 shows the actual acceleration time histories recorded at the MYG015 station compared against the accelerations recorded at the shake table during the TFP test. As shown, the shake table reproduced the horizontal accelerations very accurately in the time domain. The vertical accelerations however were deliberately reduced significantly. The accuracy of the matching is further shown in the 5% damped elastic response spectra plotted in Figure 3. These plots shows the spectra shapes were closely reproduced, and there were only minor differences in amplitudes across the frequency range of interest.

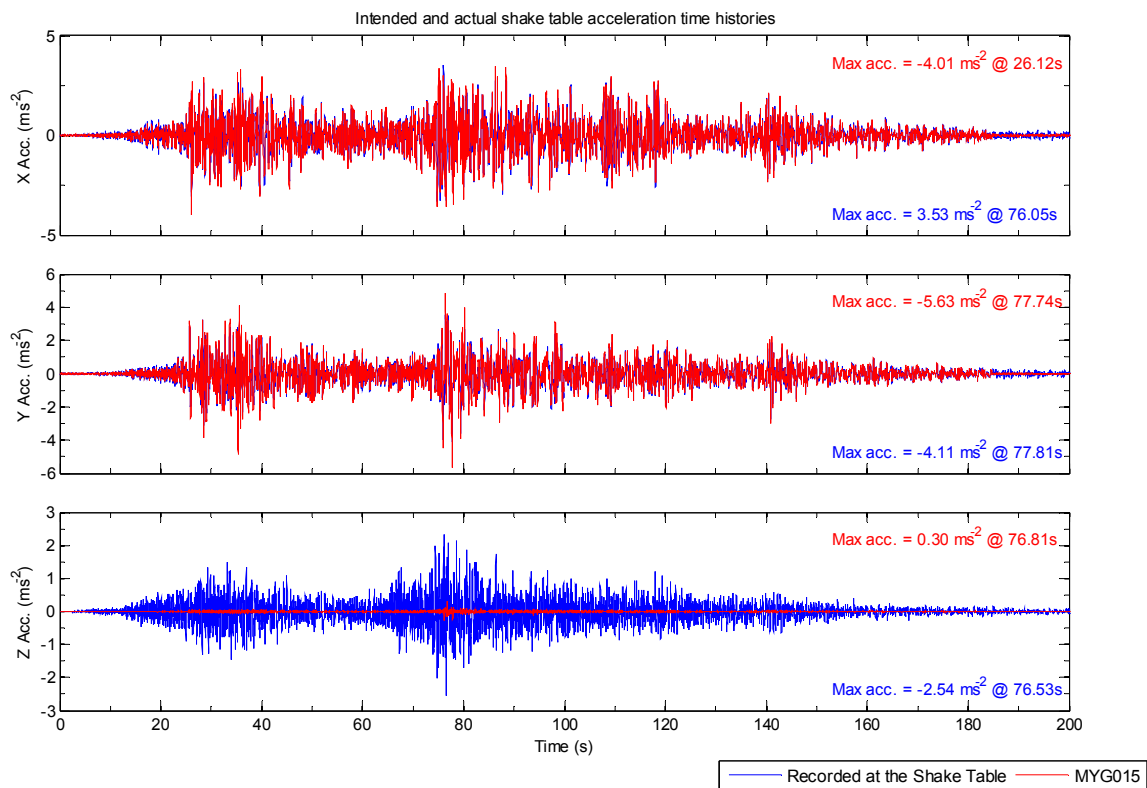

Figure 2. Acceleration time histories at the shake table and as recorded during 2011 Tohoku Earthquake record at Iwanuma Station (X direction motion compared against the EW motion)

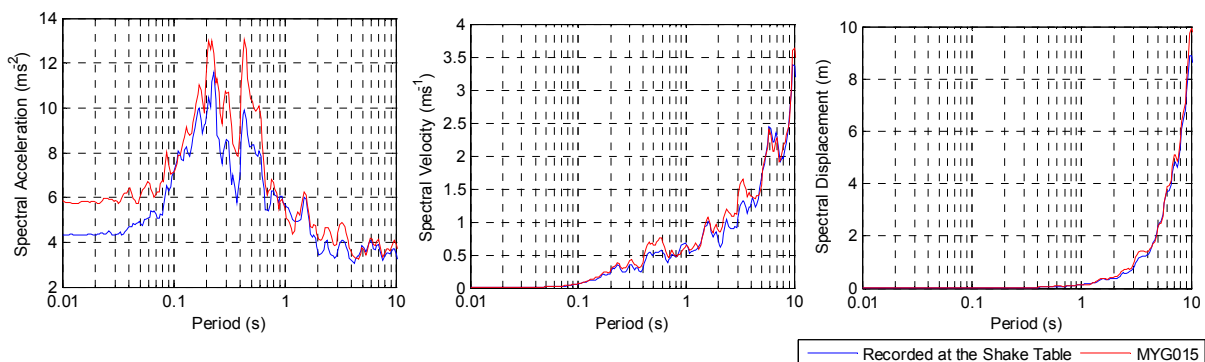

Figure 3. Response spectra of the shake table motion and the Iwanuma station motion (horizontal component)

2. MODELLING

The University of Auckland (UoA) entry used SAP2000 as the primary modelling tool (Computers and Structures 2011). The team made this decision as time constraints prohibited the development of a specific research realm program. Moreover, the team was also interested to use this opportunity to examine the abilities of a widely available commercial finite element package.

The final model was a three-dimensional model. It consisted of three main components, 1) the steel frame and composite floor, 2) mass modelling, and 3) the TFP isolators. Rayleigh damping was used with α and β parameters set to provide 3% viscous damping in the first and second modes. For the nonlinear analyses, a simple kinematic hardening model was adopted for the steel sections, and a Mander Unconfined Concrete model was used to represent the stress-strain behaviour of the concrete slab (Mander et al. 1988). The principles behind the construction of the model were to keep the model as simple as possible, and to take advantage of any advanced functions in SAP2000 to avoid making unnecessary or unjustified assumptions.

2.1 Steel Frame and Composite Floor

The UoA entry used conventional frame members at centrelines to model the columns and beams of the steel moment frame. The floors were modelled in two parts, i) as a membrane connected at the centroids of the beam elements and ii) as additional contribution to each beam sections. The additional contribution ii) represented the additional stiffness and strength contributions from the concrete slab through composite action. This was implemented by lumping an effective width of concrete slab that would contribute to the stiffness and strength to each bounding beam member. These were incorporated into the model through special cross sections created in SAP2000's section designer. A screenshot of two examples is shown in Figure 4.

This approach allowed

- the amount of composite and membrane action to be adjusted independently through the fine tuning of effective slab width;
- avoid unnecessary complications such as section torsion relating to inserting shells offset from the beam centroid; and
- permit SAP2000 to automatically calculate and incorporate the nonlinear behaviour of the composite slab via frame hinges based on fibre analyses in section designer.

This model used an effective slab width of 0.167 times the distance to the next parallel support for an edge beam, and 0.103 times the distance to the next parallel support on both sides for an interior beam. These values were selected based a series of trial-and-error analyses to obtain similar natural periods with the floors modelled as offset membranes on simple beam elements.

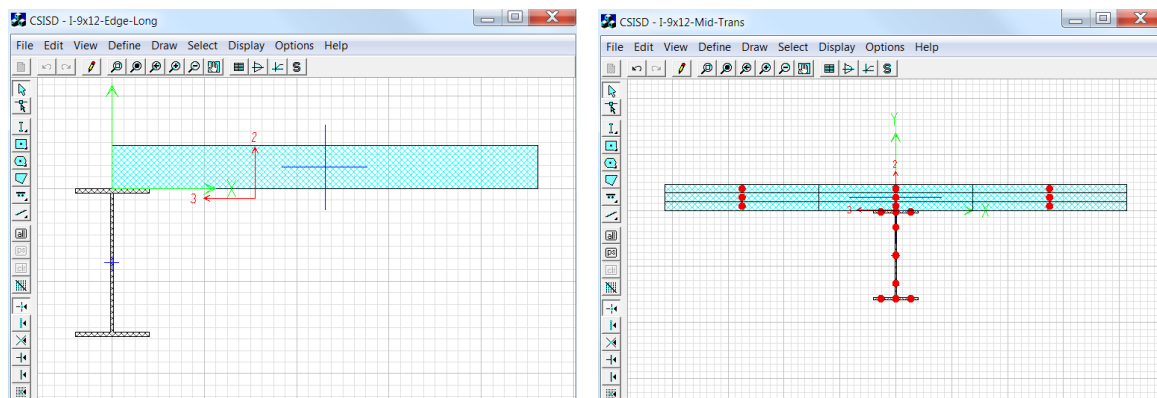

Figure 4. Screenshots of SAP2000's section designer for a perimeter and interior beam section. The screenshot on the right also shows the typical fibre arrangement used in the moment curvature fibre analysis

2.2 Mass modelling

There were three key mass contributions to the finite element model, these were the mass of the different structural elements, the mass of the non-structural elements, and the artificial steel masses added to each floor to simulate the in service floor loading.

Since the concrete floors were modelled in two parts, as membranes and as additional sections assigned to the beams. Both these sections were assigned a zero weight concrete material, and the floor masses were instead manually calculated and applied as a pressure load onto the floor membrane elements. Non-structural components mass, stemming from the internal partitions, cladding and the stairs were applied as pressure loads on the floors and point and line loads on the beams.

The mass of the additional steel mass blocks were carefully calculated and applied exactly as they were placed on the floor in order to maintain any irregular mass distribution.

2.3 TFP isolators

The specifications of the TFP isolators were provided to the contestants as a force-displacement loop, normalised to the axial load across the isolator.

The distinctive feature of the TFP isolator is that it has three different sliding surfaces with three different radii of curvature, compared to just one in a conventional concave friction pendulum isolator. Under different level of ground motion, sliding is triggered in different combinations of surfaces providing different restoring response. This enables the isolator designers to engineer different building response to different levels of ground motion. Figure 5 below graphically illustrates the behaviour of the two devices.

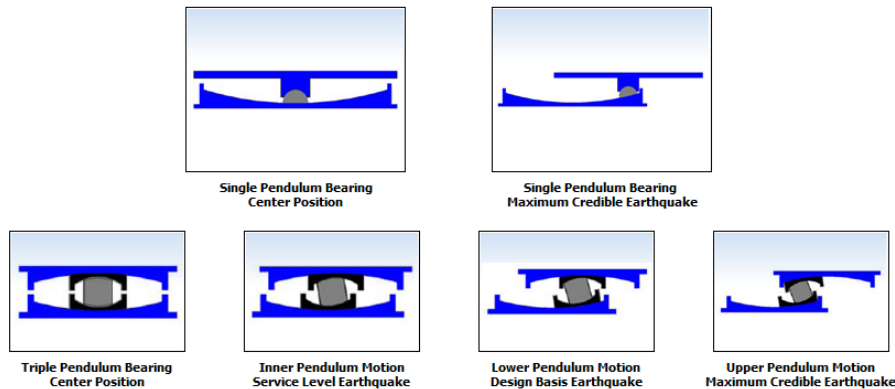

Figure 5. Comparison between TFP and a single friction pendulum (Earthquake Protection Systems 2008)

SAP2000 has a built-in nonlinear link element, the friction isolator, which reproduces the behaviour of a friction device where its restoring force is a function of the loading direction as well as the normal force across the sliding surfaces. The restoring force of a single friction isolator follows Equation 2.1,

$$F = \frac{W}{R} u_{fb} + \mu W \operatorname{sgn}(\dot{u}_{fb}) \quad (2.1)$$

where F is the restoring force of the isolator, W is the normal force across the sliding layers, R is the radius of curvature of the sliding surface, u_{fb} and \dot{u}_{fb} are the displacement and velocity between the sliding layers respectively, and μ is the coefficient of friction.

An interesting perspective in this equation is that the μW term effectively governs the maximum force at which sliding will begin and the $1/R$ term is the post-sliding "stiffness" as a multiple of W .

The UoA entry modelled each TFP using a carefully devised arrangement of two single friction isolator elements and a nonlinear gap element in parallel. A schematic of this is provided in Figure 6. The UoA team invented this arrangement as they observed that the TFP is effectively three friction pendulums set to activate at different force levels. Whilst the TFP in reality produces five different loading and unloading regimes (six different stiffness), the force displacement behaviour could be approximated to just three linear regions.

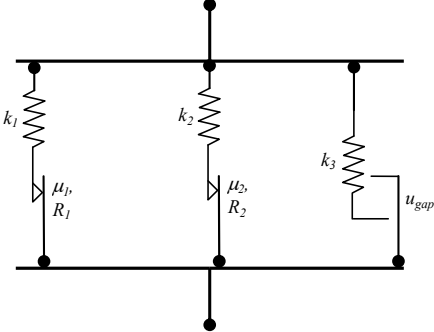

Figure 6. A schematic of a simplified TFP element implemented in SAP2000, one is required in each direction

The response for the first two linear regions can be recreated by manipulating the initial stiffness (k_1 , k_2), the coefficient of friction (μ_1 , μ_2), and the radius of curvature (R_1 , R_2) of the two friction isolator elements. μ_1 and μ_2 control the force levels at which the sliders are triggered, and R_1 and R_2 together with k_1 , k_2 control the different sliding stiffness. The final region when the largest friction pendulum reach its ends can be approximated by an additional gap element which is set to activate beyond a particular isolator displacement (u_{gap}). A diagrammatic representation of this is presented in Figure 7a. It should be noted that the weight force is assumed to be shared equally between the two frictional slider element, hence the individual sliding stiffness are $W_i/2R_1$ and $W_i/2R_2$ respectively.

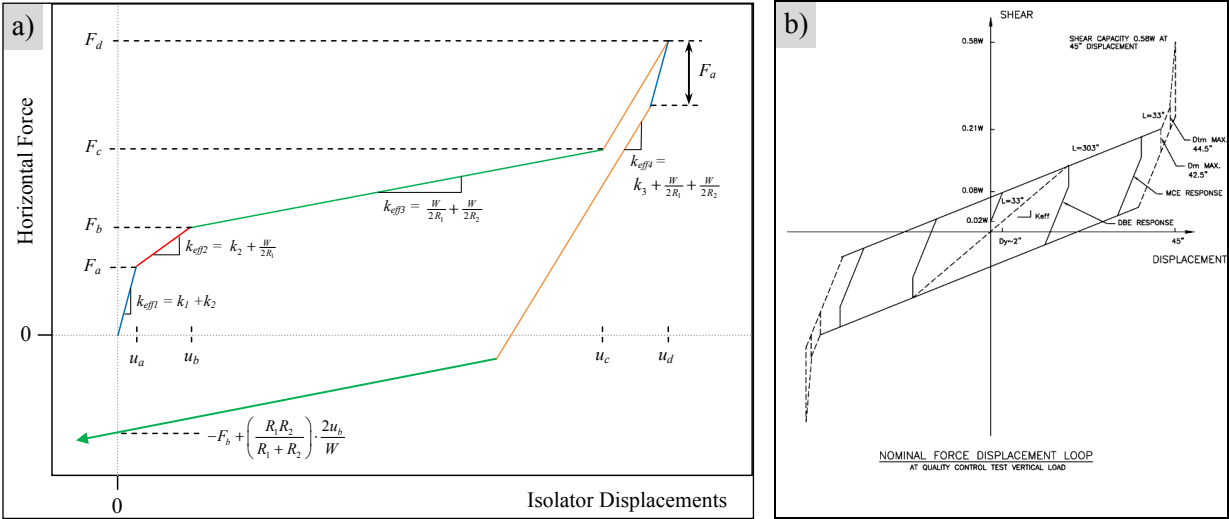

Figure 7. a) A schematic of the simplified TFP model's force-displacement response; b) The manufacturer's specification of the TFP used in the Blind Analysis Contest (Source: contest information)

A key in implementing this regime in SAP2000 is calculating parameters for the two friction pendulum arrangement such that it will correspond with the manufacturer's specification which are normal force dependent. Consequently, one must calibrate each isolator for a particular normal force (W_i). This introduces a small error in the isolator stiffness as it reaches the end of the last pendulum. Also, the exact displacement (not force level) when the second friction pendulum is activated would vary very minutely should there be a variation in normal force. An example of how these values are derived is presented herein.

Consider the manufacture's response specification shown in Figure 7b and an initial axial load (W) of 650 kN. A systems of equations can be set up to relate the individual simplified TFP element parameters in Figure 6 and the effective stiffness in the various segments in Figure 7a. From Figure 7b, assuming $0.02W$ develops over ≈ 0.15 " (10% of u_b),

$$k_{eff1} = \frac{F_a}{u_a} = \frac{0.02W}{0.15 \times 25.4} \times 1000 = 5.249W \text{ kN/m} \quad (2.1)$$

$$k_{eff2} = \frac{F_b - F_a}{u_b - u_a} = \frac{(0.075 - 0.02)W}{(1.5 - 0.15) \times 25.4} \times 1000 = 1.604W \text{ kN/m} \quad (2.2)$$

$$k_{eff3} = \frac{F_c - F_b}{u_c - u_b} = \frac{(0.21 - 0.08)W}{(42.5 - 2) \times 25.4} \times 1000 = 0.125W \text{ kN/m} \quad (2.3)$$

$$k_{eff4} = \frac{F_d - F_c}{u_d - u_c} = \frac{(0.575 - 0.205)W}{(45 - 42.5) \times 25.4} \times 1000 = 5.827W \text{ kN/m} \quad (2.4)$$

Substituting these into the equations for the different segments, yields four equations below as functions of the axial load for the five unknown parameters.

$$k_{eff1} = k_1 + k_2 = 5.249W \text{ kN/m} \quad (2.5)$$

$$k_{eff2} = k_2 + \frac{W}{2R_1} = 1.604W \text{ kN/m} \quad (2.6)$$

$$k_{eff3} = \left(\frac{1}{R_1} + \frac{1}{R_2} \right) \frac{W}{2} = 0.125W \text{ kN/m} \quad (2.7)$$

$$k_{eff4} = k_3 - k_{eff3} = 5.827W \text{ kN/m} \quad (2.8)$$

Making an assumption on any of the dependent spring parameters produces the remaining parameters. It is noted that any assumption is adequate and it would still produce the same overall effect. These leave the two unknown TFP element parameters that can be calculated as below.

$$\mu_1 = \frac{2k_1 u_a}{W} \quad (2.9)$$

$$\mu_2 = \frac{2k_2 u_b}{W} \quad (2.10)$$

Let $R_l = 5$ m for instance, this leads to the TFP element parameters in Table 2.1 below. To ensure this arrangement produces the correct response, a SAP2000 model with a single simplified TFP element was subjected to cyclic loading. Figure 8 shows the force displacement response of this simulation, and as shown, the simplified model adequately replicated the desired behaviour.

Table 2.1. Sample simplified TFP element parameters for $W = 650$ kN

$k_1 = 4869$ kN/m	$R_l = 5$ m	$\mu_l = 0.1146$	$k_2 = 1955$ kN/m
$R_2 = 20.14$ m	$\mu_2 = 0.02854$	$k_3 = 3706$ kN/m	$u_{stop} = 1.080$ m

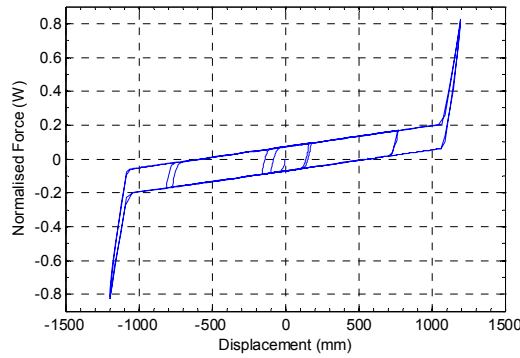
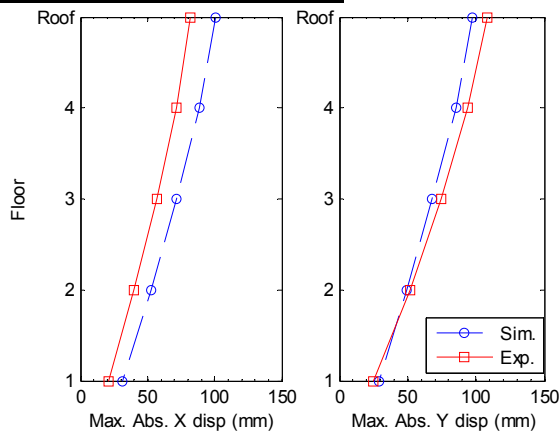

Figure 8. Force-displacement response of the simplified TFP element subjected to cyclic loading

3. COMPARISON OF SIMULATION AND SHAKE TABLE RESULTS

This section compares the simulated results against the actual responses recorded from the shake table tests. The shake table test results were kindly provided by the E-Defense Blind Analysis Contest organisers. Firstly, Figure 9 compares the maximum absolute displacements and accelerations for each floor for the fixed base and isolated structures. As depicted, the UoA SAP2000 model produced excellent matching for the fixed base structure's response both in terms of absolute magnitude and relative magnitudes across all floors.

Maximum Absolute Displacements



(Fixed based result)

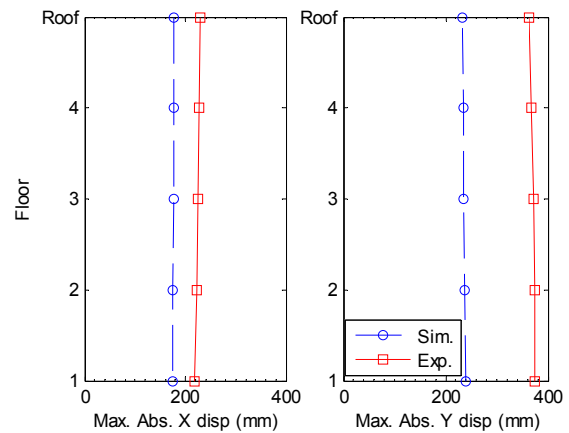

(Isolated result)

Maximum Absolute Accelerations

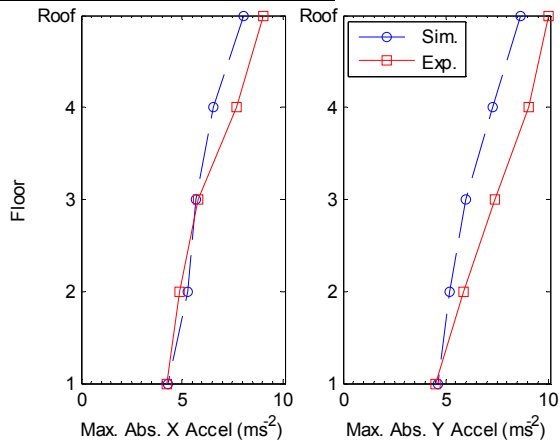

(Fixed based result)

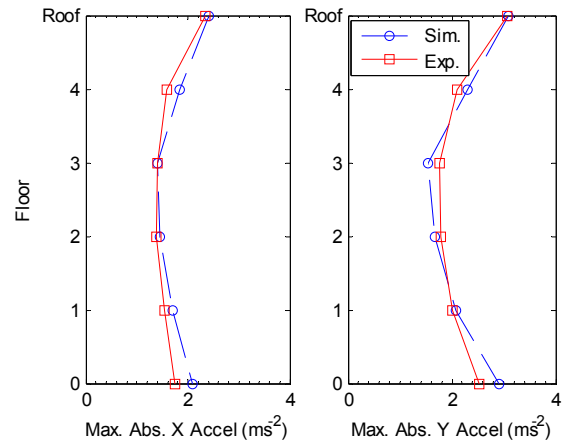

(Isolated result)

Figure 9. Comparison of simulated and as tested maximum displacements and accelerations

For the isolated structure, the relative displacements magnitudes were closely matched in both directions. However, there were slight discrepancies in the absolute displacements magnitude predictions for the x direction and up to 36% errors in the y direction. Nevertheless, the acceleration predictions for the isolated structure were very accurate, both in terms of absolute and relative magnitudes.

One of the other key assessment criteria for the competition was interstorey drift angles. Following the release of the experimental results, it was found that there were substantive discrepancies between the UoA predictions and the released data. This was unexpected given the previous close matching of maximum absolute displacements and the approximate connection between the absolute displacements and drift angles. The authors suspect errors were made by the UoA team during the drift angle calculations or different definitions were adopted.

Thus, instead of illustrating the lack of match between the submitted simulation results and actual experimental results, Figure 10 compares the displacement time histories predictions directly. As shown, the time history matching is reasonably good for both the fixed base and isolated structure.

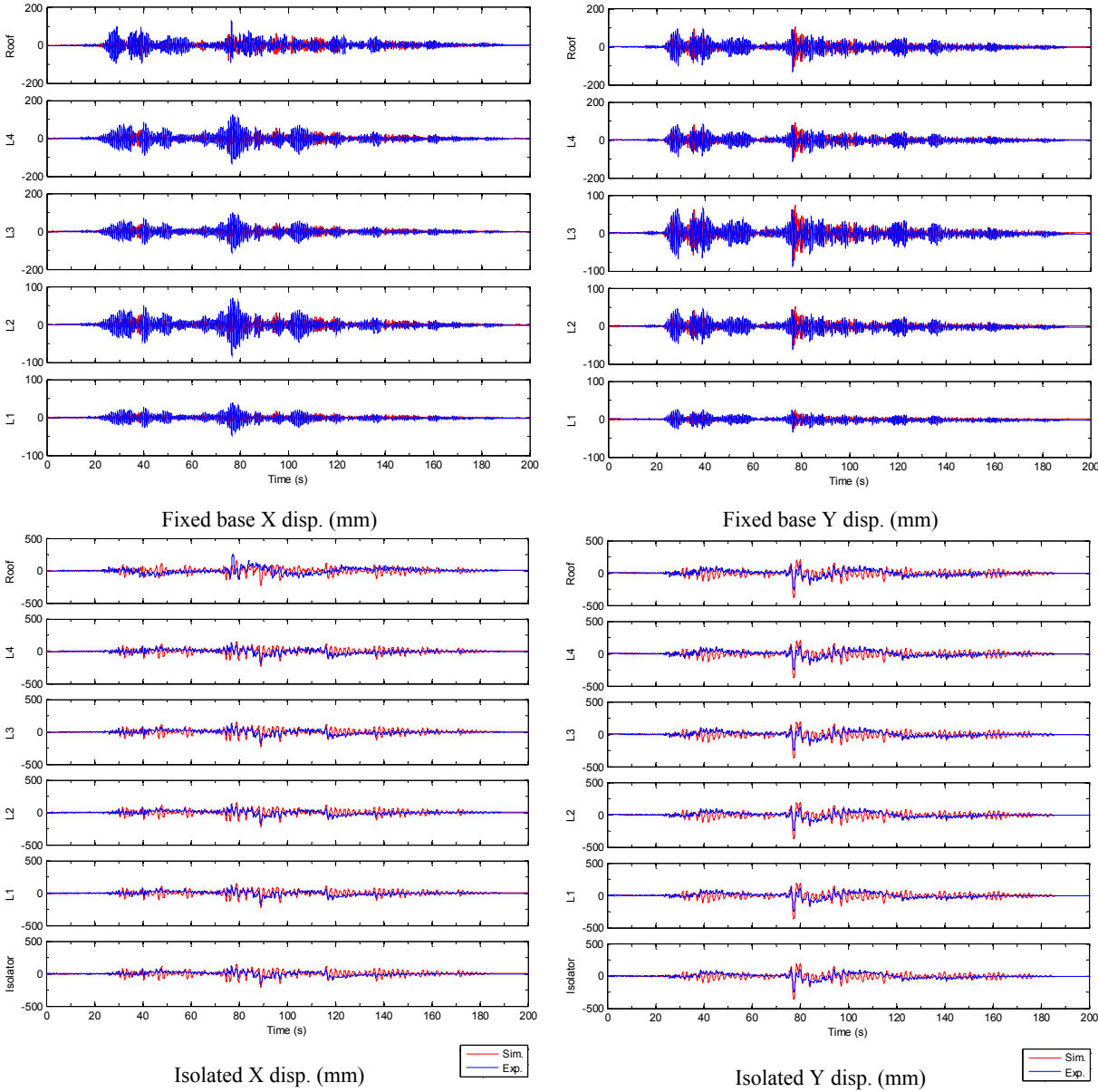

Figure 10. Comparison of simulated and experimental displacement time histories (Simulated results were measured at top of central column)

The matching of the extreme response for the peak response of the isolated structure is particularly encouraging, as it validated the use of the simplified TFP element to model the TFP systems. Figure 11 below shows the simulated base shear response versus the displacement of the central isolator.

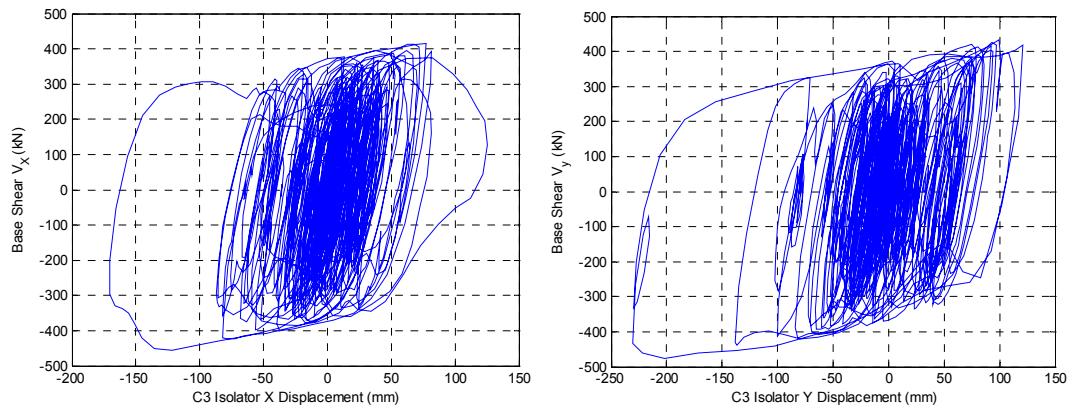

Figure 11. Base shear versus isolator displacements from SAP2000 simulation

4. CONCLUSION

This paper presents a summary of the Blind Analysis Contest entry by the University of Auckland team. The entry used SAP2000 as the primary modelling tool and the prediction procedure mimicked the design process in a typical engineering consultancy. The contest participation enabled the team to examine the ability for this commercial finite element software to model complex nonlinear weight force dependent behaviour. Despite the University of Auckland entry did not produce an excellent result using the contest predefined assessment criteria, actual time histories prediction clearly showed that the model in fact captured the response well. The failure to produce the correct assessment criteria may be a problem in the post analysis calculations or an erroneous definition of drift angles.

ACKNOWLEDGEMENT

The authors would like to thank the Centre for Urban Earthquake Engineering (CUEE), Japan and the Network for Earthquake Engineering Simulation (NEES) inc. U.S. for organising and supporting this incredible research and learning opportunity. Particular thanks to the Blind Analysis Contest organiser, Dr. Troy Morgan, for his assistance throughout the competition and his help in providing the experimental results, post competition.

REFERENCES

- Center for Urban Earthquake Engineering. (2011). Blind Analysis Contest Application Site. Retrieved 19 April, 2012, from <http://cuee.arch.titech.ac.jp/~ksato/hp/eng/outline/outline.html>.
- Computers and Structures, Inc. (2011). "SAP2000 v14 - Integrated Structural Analysis & Design Software." Computers and Structures, Inc.
- Earthquake Protection Systems. (2008). Earthquake Protection System: Triple and Single Pendulum Motion, Mare Island, Vallejo, California. Retrieved 22 April, 2012, from http://www.earthquakeprotection.com/triple_vs_single_pendulum.html.
- Fenz, D. M., and Constantinou, M. C. (2008). Modeling Triple Friction Pendulum Bearings for Response-History Analysis. *Earthquake Spectra*, **24** (4), 1011-1028.
- Mander, J. B., Priestley, M. J. N., and Park, R. (1988). Theoretical Stress-Strain Model for Confined Concrete. *Journal of structural engineering New York, N.Y.*, **114** (8), 1804-1826.
- Mayes, R. L., Jones, L. R., and Buckle, I. G. (1990). Impediments to the Implementation of Seismic Isolation. *Earthquake Spectra*, **6** (2), 283-296.
- Morgan, T. A. (2007). "The Use of innovative base isolation systems to achieve complex seismic performance objectives," University of California, Berkeley.
- Morgan, T. A., and Mahin, S. A. (2010). Achieving reliable seismic performance enhancement using multi-stage friction pendulum isolators. *Earthquake Engineering & Structural Dynamics*, **39** (13), 1443-1461.
- Motoyui, S., Hikino, T., Ishii, M., Ito, H., Ozaki, H., Kasai, K., and Kajiwara, K. (2009). "Full-scale tests of passively-controlled 5-story steel building using E-Defense shake table Part 1." Behaviour of Steel Structures in Seismic Areas, CRC Press.
- Ryan, K. L., Mahin, S. A., and Mosqueda, G. (2008). Introduction to NEES TIPS: Tools for Isolation and Protective Systems. 18th Analysis and Computation Specialty Conference. ASCE.